

Technical data sheet

TP support / wall and support bracket FT



Item number: 6366139



TP bracket with clamping lugs.

If the bracket is fastened directly to the wall or the profiles are screwed together, then, for reasons of stability, always use the spacer, type DS 4.

Mesh cable trays with a 50 x 100 mm grid width, e.g. type GRL, GR and GRM, can be fastened to the TP bracket without screws.



St Steel

FT Hot-dip galvanised

Master data

Item number	6366139
Type	TPSAG 245 FT
Description 1	TP wall and support bracket
Description 2	for mesh cable tray
Manufacturer	OBO
Dimension	B245mm
Material	Steel
Surface	Hot-dip galvanised
Surface standard	DIN EN ISO 1461
Smallest sales unit	1
Unit of quantity	Piece
Weight	49 kg
Weight unit	kg/100 pc.

Technical data sheet

TP support / wall and support bracket FT



Item number: 6366139

Dimensions

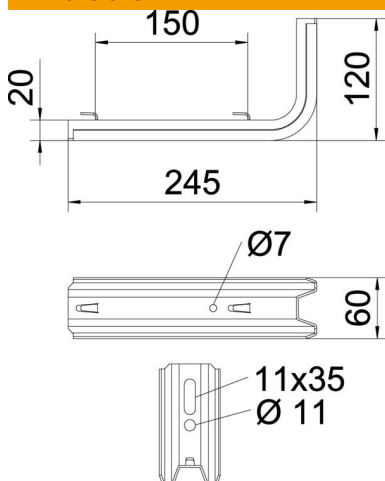

Length	245 mm
Width	60 mm
Height	120 mm
Dimension B	60 mm
Dimension H	120 mm
Dimension L	245 mm
Maß W	150 mm

Technical data

Version for	Wall and support bracket
F in kN	0.9 kN
Maintain electrical functions	no
for width max.	200 mm
for width min.	200
Rustproof steel, pickled	no

Loads

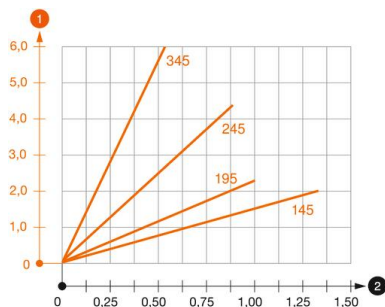

Load diagram, bracket, type TPSAG

- 1 Bending of the bracket tip at permitted bracket load
- 2 Permitted bracket load in kN without man load
- 2 Support width in m

Characteristic anchor load values for TP bracket

Anchor type	Wall fastening			
	Max. load [kN]			
	Bracket width [mm]			
	145	195	245	345
BZ3 10x90/0-30	1.3	0.93	0.60	0.55

The load capacity values increase considerably when used in uncracked concrete. The stated values are based on cracked concrete of compressive strength C20/25. Please comply with the installation conditions of ETA(anchors).