

Technical data sheet

Adjustable bend element 110 FT

Item number: 6225540



Adjustable bend element, heavy-duty, with welded rung for use in the cable ladder types with a side height of 110 mm.



CE

St Steel

FT Hot-dip galvanised

Master data

Item number	6225540
Type	SLGBE 1160 FT
Description 1	Adjustable bend element
Description 2	for cable ladder
Manufacturer	OBO
Dimension	110x600
Material	Steel
Surface	Hot-dip galvanised
Surface standard	DIN EN ISO 1461
Smallest sales unit	1
Unit of quantity	Piece
Weight	248.6 kg
Weight unit	kg/100 pc.

Technical data sheet

Adjustable bend element 110 FT

Item number: 6225540



Dimensions

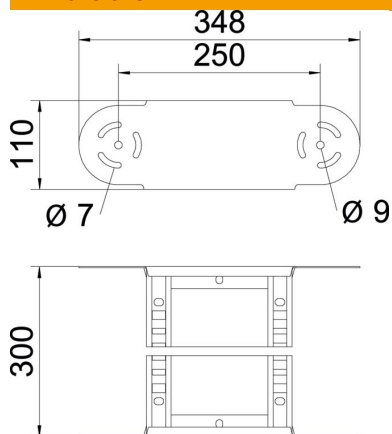

Width	600 mm
Height	110 mm
Dimension B	600 mm
Dimension R	600 mm

Technical data

Bend (angle)	Adjustable
Version of the rungs	Profile perforated
Side rail version	Flat profile
Connector version	Integrated connector
Maintain electrical functions	no
Change of direction	Vertical, rising/falling
Rustproof steel, pickled	no
Hinged	yes
Side perforation	no
Wide-span version	no
Rail thickness	2 mm