

Technical data sheet

45° bend 85 FT

Item number: 7067313

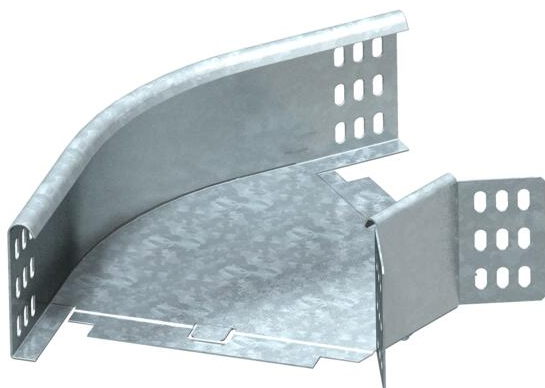

45° bend, horizontal, for all cable tray types of 85 mm side height.
The fitting is shipped in an unmounted state. The WKV 85 angle connector is designed for 90° bends and can be adjusted to 45° on site.
Including appropriate fastening material.



St Steel

FT Hot-dip galvanised

Master data

Item number	7067313
Type	RB 45 830 FT
Description 1	45° bend
Description 2	horizontal + angle connector
Manufacturer	OBO
Dimension	85x300
Material	Steel
Surface	Hot-dip galvanised
Surface standard	DIN EN ISO 1461
Smallest sales unit	1
Unit of quantity	Piece
Weight	130 kg
Weight unit	kg/100 pc.

Technical data sheet

45° bend 85 FT

Item number: 7067313



Dimensions

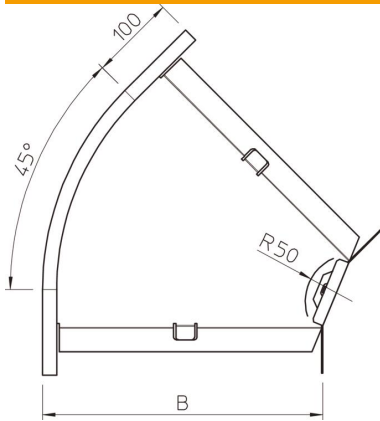

Width	300 mm
Width	12 in
Height	85 mm
Height	3 in
Plate thickness	1 mm
Dimension B	300 mm
Dimension R	50 mm

Technical data

Bend (angle)	45°
Connector version	Supplied connectors
Maintain electrical functions	no
Mounting perforation in base	no
NATO hole pattern	no
Change of direction	Horizontal
Rustproof steel, pickled	no
Side perforation	no
Wide-span version	no
Type of connector, cable support system	Screwed