

Technical data sheet

90° vertical bend, falling 60 A2

Item number: 7007155



90° vertical bend, falling, for all cable tray types of 60 mm side height.
The vertical bend is pushed over the end of the cable tray and screwed tight.
Fastening materials should be ordered separately.



A2 Stainless steel

2B Bright, treated

Master data

Item number	7007155
Type	RBV 610 F A2
Description 1	90° vertical bend
Description 2	falling
Manufacturer	OBO
Dimension	60x100
Material	Stainless steel
Surface	Bright, treated
Surface standard	
Smallest sales unit	1
Unit of quantity	Piece
Weight	61 kg
Weight unit	kg/100 pc.

Technical data sheet

90° vertical bend, falling 60 A2

Item number: 7007155



Dimensions

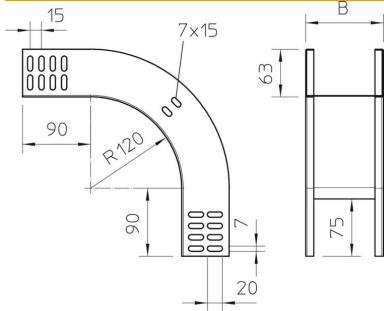

Width	100 mm
Width	4 in
Height	60 mm
Height	2 in
Plate thickness	1 mm
Dimension B	100 mm

Technical data

Bend (angle)	90°
Connector version	Without connectors
Maintain electrical functions	no
Mounting perforation in base	no
NATO hole pattern	no
Change of direction	Vertical, falling
Rustproof steel, pickled	no
Side perforation	no
Wide-span version	no
Type of connector, cable support system	Screwed