

Technical data sheet

45° bend 60 A4

Item number: 7133273



45° bend, horizontal and unperforated, for all cable tray types of 60 mm side height.
Fitting, unperforated, in round design. The interior radius of the fitting is 150 mm.
Fastening materials should be ordered separately.



A4 Stainless steel

2B Bright, treated

Master data

Item number	7133273
Type	RBU 45 650 A4
Description 1	45° bend
Description 2	unperforated, round type
Manufacturer	OBO
Dimension	60x500
Material	Stainless steel
Surface	Bright, treated
Surface standard	
Smallest sales unit	1
Unit of quantity	Piece
Weight	385.9 kg
Weight unit	kg/100 pc.

Dimensions

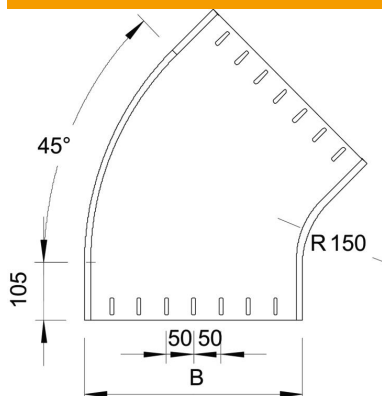

Width	500 mm
Width	20 in
Height	60 mm
Height	2 in
Plate thickness	1.5 mm
Dimension B	500 mm
Dimension R	150 mm

Technical data sheet

45° bend 60 A4

Item number: 7133273



Technical data

Bend (angle)	45°
Connector version	Without connectors
Maintain electrical functions	no
Mounting perforation in base	no
NATO hole pattern	no
Change of direction	Horizontal
Rustproof steel, pickled	no
Side perforation	no
Wide-span version	no
Type of connector, cable support system	Screwed