

# Technical data sheet

Vertical bend, three-compartment, height 48 mm

Item number: 7400652



For vertical direction changes of screed-covered underfloor installation ducts (wall connections, supplies).

An important precondition for correct underfloor installation is the screed structure.

In the case of a screed-covered system, it is important that the screed thickness of the duct is at least 35 mm, to avoid the formation of cracks (DIN 18560).

Screed height: 60 mm only for on-floor connection technology (Telitank), 70 mm or more for underfloor connection technology.



**St** Steel

**FS** Strip galvanized

## Master data

Item number	7400652
Type	KV3 25048
Description 1	Vertical bend
Description 2	3 compartments for EÜK
Manufacturer	OBO
Material	Steel
Surface	Strip galvanized
Surface standard	DIN EN 10346
Smallest sales unit	1
Unit of quantity	Piece
Weight	233 kg
Weight unit	kg/100 pc.

# Technical data sheet

Vertical bend, three-compartment, height 48 mm

Item number: 7400652



## Dimensions

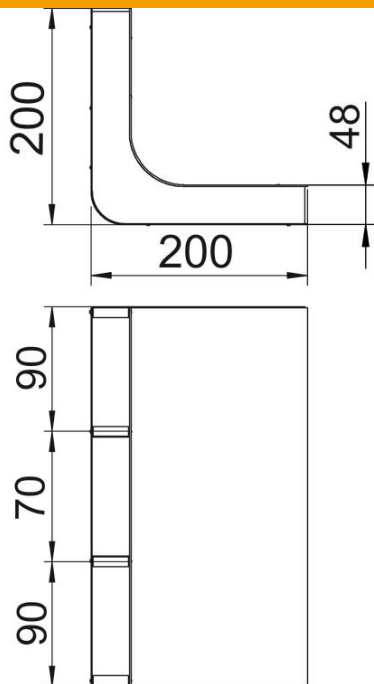

Length	200 mm
Width	250 mm
Height	48 mm
Dimension a	90 mm
Dimension b	70 mm
Dimension h	48 mm

## Technical data

Number of fixed partitions	2
Number of compartments	3 St.
Suitable for screed-flush closed underfloor ducts	no
Suitable for screed-covered underfloor ducts	yes
Trunking width, min.	250 mm
Duct height, min.	48 mm
Cross-section, draw a	4048 mm <sup>2</sup>
Cross-section, draw b	3174 mm <sup>2</sup>