

# Technical data sheet

## Cover for 90° Magic bend A2

Item number: 7138572



Cover for 90° bend with pre-mounted turn buckles.  
The cover can be used with fittings of all side heights.



**A2** Stainless steel

**2B** Bright, treated

### Master data

Item number	7138572
Type	DFBM 90 150 A2
Description 1	90° bend cover
Description 2	for bend RBM 90 150
Manufacturer	OBO
Dimension	B=150mm
Material	Stainless steel
Surface	Bright, treated
Surface standard	
Smallest sales unit	1
Unit of quantity	Piece
Weight	29.9 kg
Weight unit	kg/100 pc.

# Technical data sheet

## Cover for 90° Magic bend A2

Item number: 7138572



### Dimensions

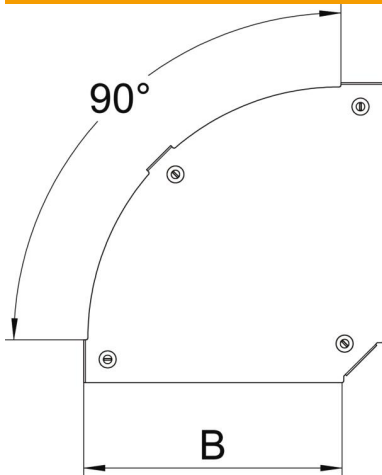

Width	150 mm
Plate thickness	1.25 mm
Dimension B	150 mm

### Technical data

Bend (angle)	90°
Fastening type	Sash lock
Maintain electrical functions	no
Suitable for mesh cable tray	no
Suitable for cable ladder	yes
Suitable for cable tray	yes
Change of direction	Horizontal
Rustproof steel, pickled	no
Hinged	no