

Technical data sheet

Cover for 45° Magic bend A2

Item number: 7138430



Cover for 45° bend with pre-mounted turn buckles.
The cover can be used with fittings of all side heights.



A2 Stainless steel

2B Bright, treated

Master data

Item number	7138430
Type	DFBM 45 100 A2
Description 1	45° bend cover
Description 2	for bend RBM 45 100
Manufacturer	OBO
Dimension	B=100mm
Material	Stainless steel
Surface	Bright, treated
Surface standard	
Smallest sales unit	1
Unit of quantity	Piece
Weight	13.1 kg
Weight unit	kg/100 pc.

Technical data sheet

Cover for 45° Magic bend A2

Item number: 7138430

Dimensions

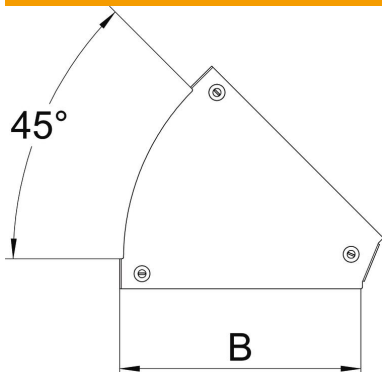

Width	100 mm
Plate thickness	1.25 mm
Dimension B	100 mm

Technical data

Bend (angle)	45°
Fastening type	Sash lock
Maintain electrical functions	no
Suitable for mesh cable tray	no
Suitable for cable ladder	yes
Suitable for cable tray	yes
Change of direction	Horizontal
Rustproof steel, pickled	no
Hinged	no