

Technical data sheet

Cable and pipe spacer clip 733 V2A

Item number: 1362100



- * Size M16 is not suitable for nail device
- * Sizes M16 - PG16 are not suitable for bolt-firing tool



A2 Stainless steel

2B Bright, treated

Master data

Item number	1362100
Type	733 61 A2
Description 1	Distance saddle
Description 2	with slot
Manufacturer	OBO
Dimension	53-61mm
Material	Stainless steel
Surface	Bright, treated
Surface standard	
Smallest sales unit	20
Unit of quantity	Piece
Weight	6.8 kg
Weight unit	kg/100 pc.

Technical data sheet

Cable and pipe spacer clip 733 V2A

Item number: 1362100



Dimensions

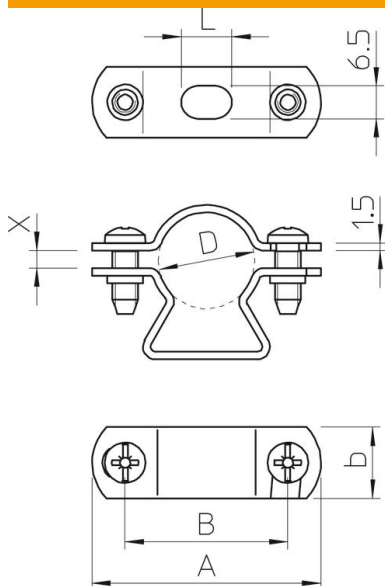

Dimension A	96 mm
Dimension B	78 mm
Dimension b	18 mm
Dimension D	61 mm
Dimension d min.	61 mm
Dimension L	14 mm
Dimension x	12.5 mm

Technical data

Distance to the wall	yes
Number of cables/pipes	1
Version for	Closed
Fastening type	Screw hole
Suitable in fire protection area	yes
Size	Pg48
Halogen-free	yes
Plastic-covered	no
Hole size	6,5 x 14 mm
Material thickness	1.5 mm
Bolt	M5 x 18
Clamping range D, max.	61 mm
Clamping range D, min.	53 mm
UV-resistant	yes