

Technical data sheet

Cable and pipe spacer clip 733 G

Item number: 1361511



- * Size M16 is not suitable for nail device
- * Sizes M16 - PG16 are not suitable for bolt-firing tool



St Steel

G Electrogalvanized

Master data

Item number	1361511
Type	733 54 G
Description 1	Distance saddle
Description 2	with slot
Manufacturer	OBO
Dimension	48-54mm
Material	Steel
Surface	Electrogalvanized
Surface standard	EN ISO 19598 / EN ISO 4042
Smallest sales unit	25
Unit of quantity	Piece
Weight	5.8 kg
Weight unit	kg/100 pc.

Technical data sheet

Cable and pipe spacer clip 733 G

Item number: 1361511



Dimensions

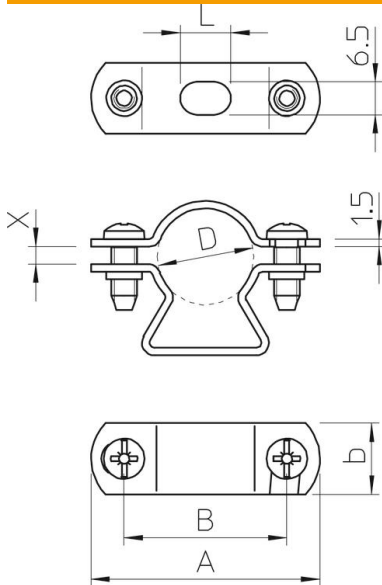

Length	86 mm
Dimension A	86 mm
Dimension B	68 mm
Dimension b	18 mm
Dimension D	54 mm
Dimension L	14 mm
Dimension x	11.75 mm

Technical data

Distance to the wall	yes
Number of cables/pipes	1
Version for	Closed
Fastening type	Screw hole
For diameter	54
Suitable in fire protection area	yes
Size	M50
Halogen-free	yes
Plastic-covered	no
Hole size	6,5 x 14 mm
Material thickness	1.5 mm
Bolt	M5 x 18
Clamping range D, max.	54 mm
Clamping range D, min.	48 mm
UV-resistant	yes