

Technical data sheet

Cable and pipe spacer clip 733 FT

Item number: 1361117



* Size M16 is not suitable for nail device.
* Sizes M16 to PG16 not suitable for bolt-firing tool.



St Steel

FT Hot-dip galvanised

Master data

Item number	1361117
Type	733 54 FT
Description 1	Distance saddle
Description 2	with slot
Manufacturer	OBO
Dimension	48-54mm
Material	Steel
Surface	Hot-dip galvanised
Surface standard	DIN EN ISO 1461
Smallest sales unit	25
Unit of quantity	Piece
Weight	5.4 kg
Weight unit	kg/100 pc.

Technical data sheet

Cable and pipe spacer clip 733 FT

Item number: 1361117



Dimensions

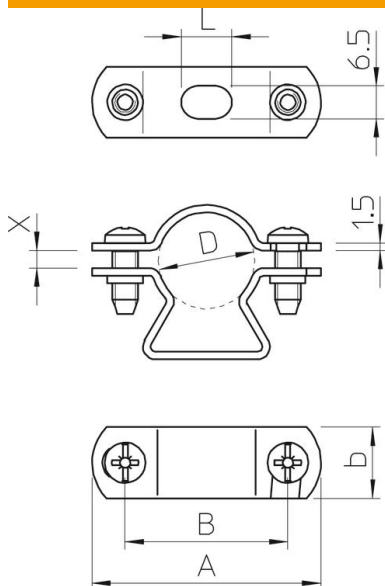

Length	86 mm
Width	18 mm
Dimension A	86 mm
Dimension B	68 mm
Dimension b	18 mm
Dimension L	14 mm
Dimension x	7.5 mm

Technical data

Distance to the wall	yes
Number of cables/pipes	1
Version for	Closed
Fastening type	Screw hole
Suitable in fire protection area	yes
Size	M50
Halogen-free	yes
Plastic-covered	no
Hole size	6,5 x 14 mm
Material thickness	1.5 mm
Bolt	M5 x 18
Clamping range D, max.	54 mm
Clamping range D, min.	48 mm
UV-resistant	yes