

Technical data sheet

Cable and pipe spacer clip 733 V2A

Item number: 1362070



- * Size M16 is not suitable for nail device
- * Sizes M16 - PG16 are not suitable for bolt-firing tool



A2 Stainless steel

2B Bright, treated

Master data

Item number	1362070
Type	733 38 A2
Description 1	Distance saddle
Description 2	with slot
Manufacturer	OBO
Dimension	30-38mm
Material	Stainless steel
Surface	Bright, treated
Surface standard	
Smallest sales unit	25
Unit of quantity	Piece
Weight	4.5 kg
Weight unit	kg/100 pc.

Technical data sheet

Cable and pipe spacer clip 733 V2A

Item number: 1362070



Dimensions

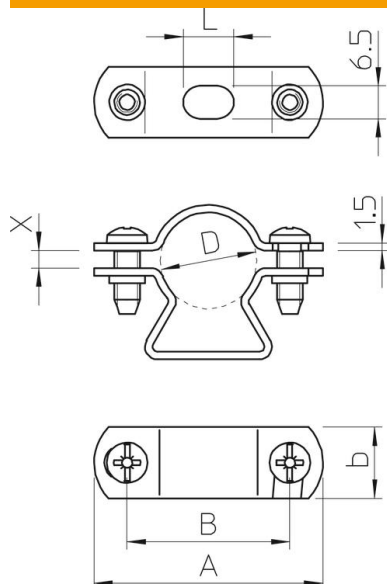

Dimension A	70 mm
Dimension B	54 mm
Dimension b	16 mm
Dimension D	38 mm
Dimension d min.	38 mm
Dimension L	10 mm
Dimension x	11.5 mm

Technical data

Distance to the wall	yes
Number of cables/pipes	1
Version for	Closed
Fastening type	Screw hole
Suitable in fire protection area	yes
Size	M32
Halogen-free	yes
Plastic-covered	no
Hole size	6,5 x 10 mm
Material thickness	1.5 mm
Bolt	M5 x 18
Clamping range D, max.	38 mm
Clamping range D, min.	30 mm
UV-resistant	yes