

Technical data sheet

Cable and pipe spacer clip 733 V2A

Item number: 1362054



- * Size M16 is not suitable for nail device
- * Sizes M16 - PG16 are not suitable for bolt-firing tool



A2 Stainless steel

2B Bright, treated

Master data

Item number	1362054
Type	733 23 A2
Description 1	Distance saddle
Description 2	with slot
Manufacturer	OBO
Dimension	21-23mm
Material	Stainless steel
Surface	Bright, treated
Surface standard	
Smallest sales unit	50
Unit of quantity	Piece
Weight	2.8 kg
Weight unit	kg/100 pc.

Technical data sheet

Cable and pipe spacer clip 733 V2A

Item number: 1362054



Dimensions

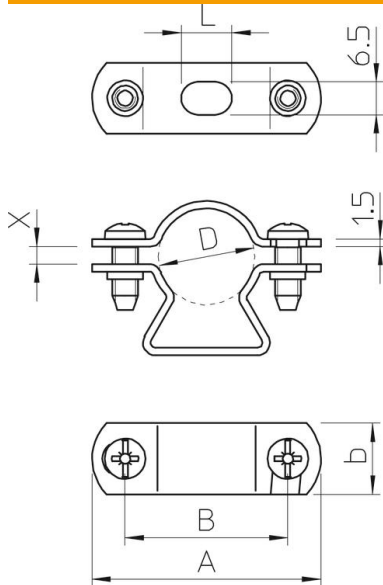

Dimension A	52 mm
Dimension B	39 mm
Dimension b	14 mm
Dimension D	23 mm
Dimension d min.	23 mm
Dimension L	10 mm
Dimension x	9.25 mm

Technical data

Distance to the wall	yes
Number of cables/pipes	1
Version for	Closed
Fastening type	Screw hole
Suitable in fire protection area	yes
Size	Pg16
Halogen-free	yes
Plastic-covered	no
Hole size	6,5 x 10 mm
Material thickness	1.5 mm
Bolt	M5 x 16
Clamping range D, max.	23 mm
Clamping range D, min.	21 mm
UV-resistant	yes